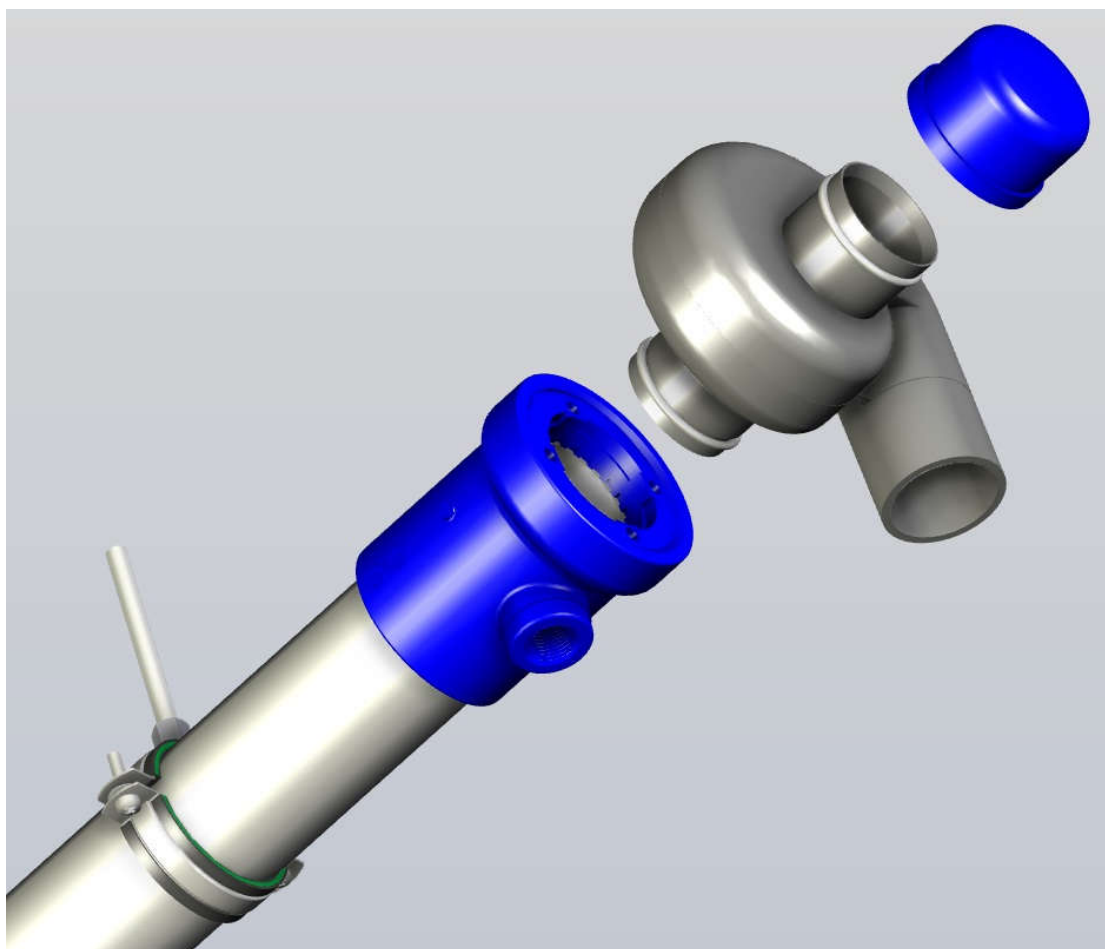

EN

Shower Pipe WWHR - Counter Flow VX 1700
Shower Pipe WWHR - Counter Flow VX 2100
Shower Pipe WWHR - Counter Flow VX 2100 HF (High Flow)

Technical sheet / Installation manual

- Always respect the applicable local laws and regulations
- Installation must be carried out by professional installer, in accordance with this installation manual
- Non-compliance installation will lead to loss of warranty

**Index**

| | | |
|----|---|--------|
| 1. | Technical data, connections, content & sketches | Page 2 |
| 2. | Technical specifications, performance & connection diagrams & warranty | Page 3 |
| 3. | Energy savings, safety & comfort, considerations <i>before</i> mounting | Page 4 |
| 4. | Mounting instructions | Page 5 |

Technical data & connections

| Pos. | Qty | Component | Technical data / connections | |
|------|-----|--|--|---|
| 1 | 1x | Double walled, full copper heat exchanger (Cu-DHP), PVC-U outer shell \varnothing 63mm | VX 1700 VX 2100 VX 2100 HF | \varnothing 92mm x 1700mm; weight 6,8kg \varnothing 92mm x 2100mm; weight 8,2kg \varnothing 92mm x 2100mm; weight 8,3kg |
| 2 | 1x | TURBO rotator | ABS; clock- or anti-clockwise inlet accelerator; \varnothing 50mm smooth | |
| 3 | 1x | Cap | LDPE; \varnothing 50mm sleeve | |
| 4 | 2x | Mounting bracket with rubber inlay | Galvanized steel; DÄMMGULAST®; \varnothing 63mm | |
| 5 | 2x | Stair bolt | Galvanized steel; M8 x 100mm | |
| 6 | 1x | Coupling insert with O-ring | PVC; \varnothing 50mm with EPDM O-ring / \varnothing 50mm smooth | |
| 7 | - | Potable water connections | 1/2" inner thread (BSP-Par.), with stainless steel reinforced ring | |
| 8* | - | Middle T-sprout | PVC; \varnothing 63mm x 3/4" inside thread (BSP, parallel) | |
| 9* | - | Potable water connection(middle) | 3/4" inner thread (BSP, parallel); cold water inlet | |
| 10* | 1x | Double nipple with sealing | Brass; 3/4" outside thread (BSP, parallel); nitrile rubber seal | |

*) only for VX 2100 HF (cold water inlet to middle connection)

Content & sketches

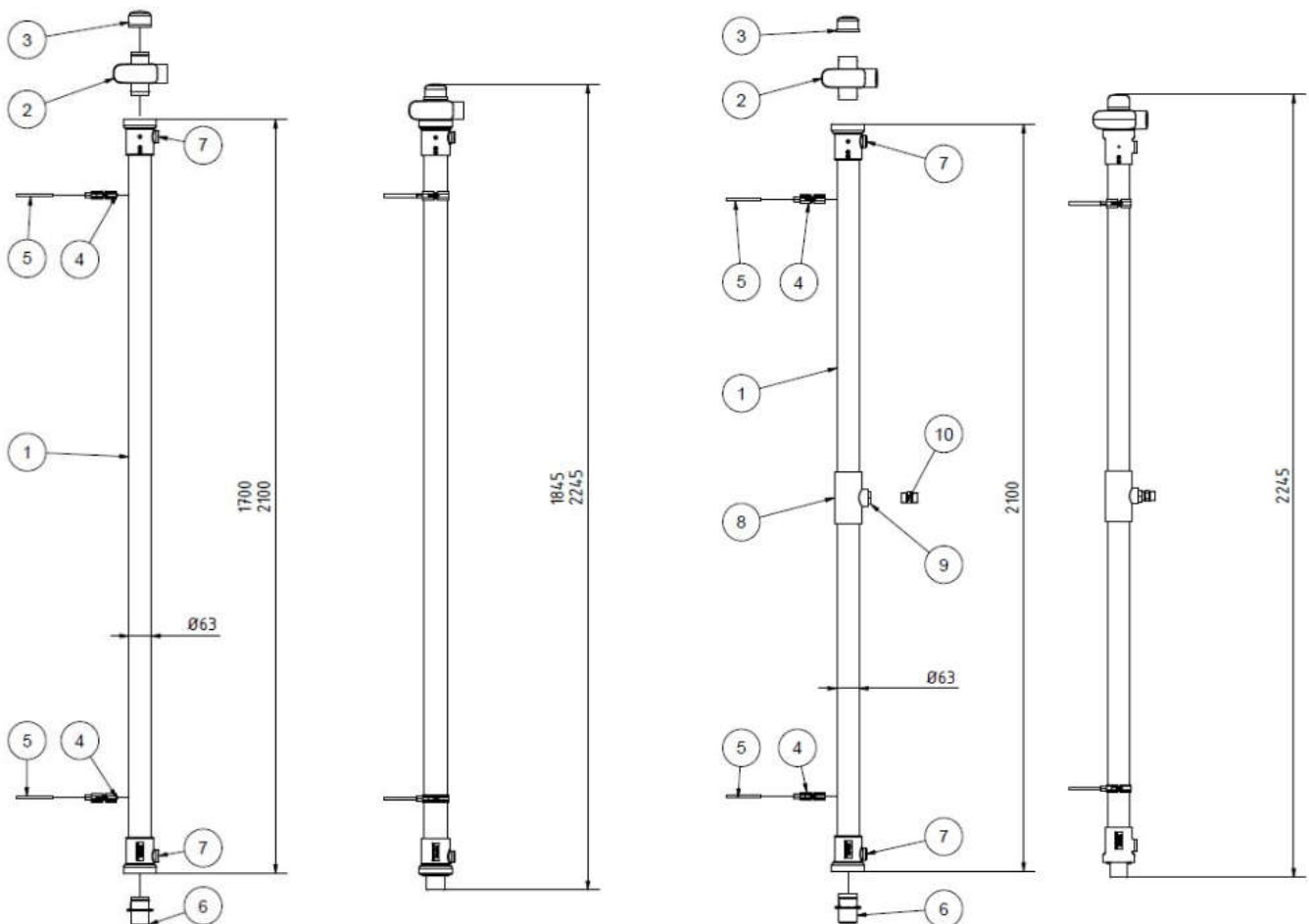

Technical specifications & performance

| | VX 1700 | VX 2100 | VX 2100 HF |
|--|----------|----------|------------|
| Efficiency (KIWA, conform NEN7120 / NTA8800; 9,2 l/min) | 60,0% | 65,2% | - |
| Efficiency (KIWA, conform NEN7120 / NTA8800; 12,5 l/min) | 55,5% | 62,5% | 52,6% |
| BCRG approval | Yes | Yes | Yes |
| Pressure drop (9,2 l/min) | 0,26 bar | 0,39 bar | 0,10 bar |
| Max. Flowrate potable water | 15 l/min | 15 l/min | 30 l/min |
| Max. Flowrate waste water | 30 l/min | 30 l/min | 30 l/min |
| Content potable water | 0,30 ltr | 0,35 ltr | 0,36 ltr |
| Max. pressure (potable water side) | 7,5 bar | | |
| Max. pressure (waste water side) | 1,0 bar | | |
| Max. temperature | 60 °C | | |

Connection diagrams

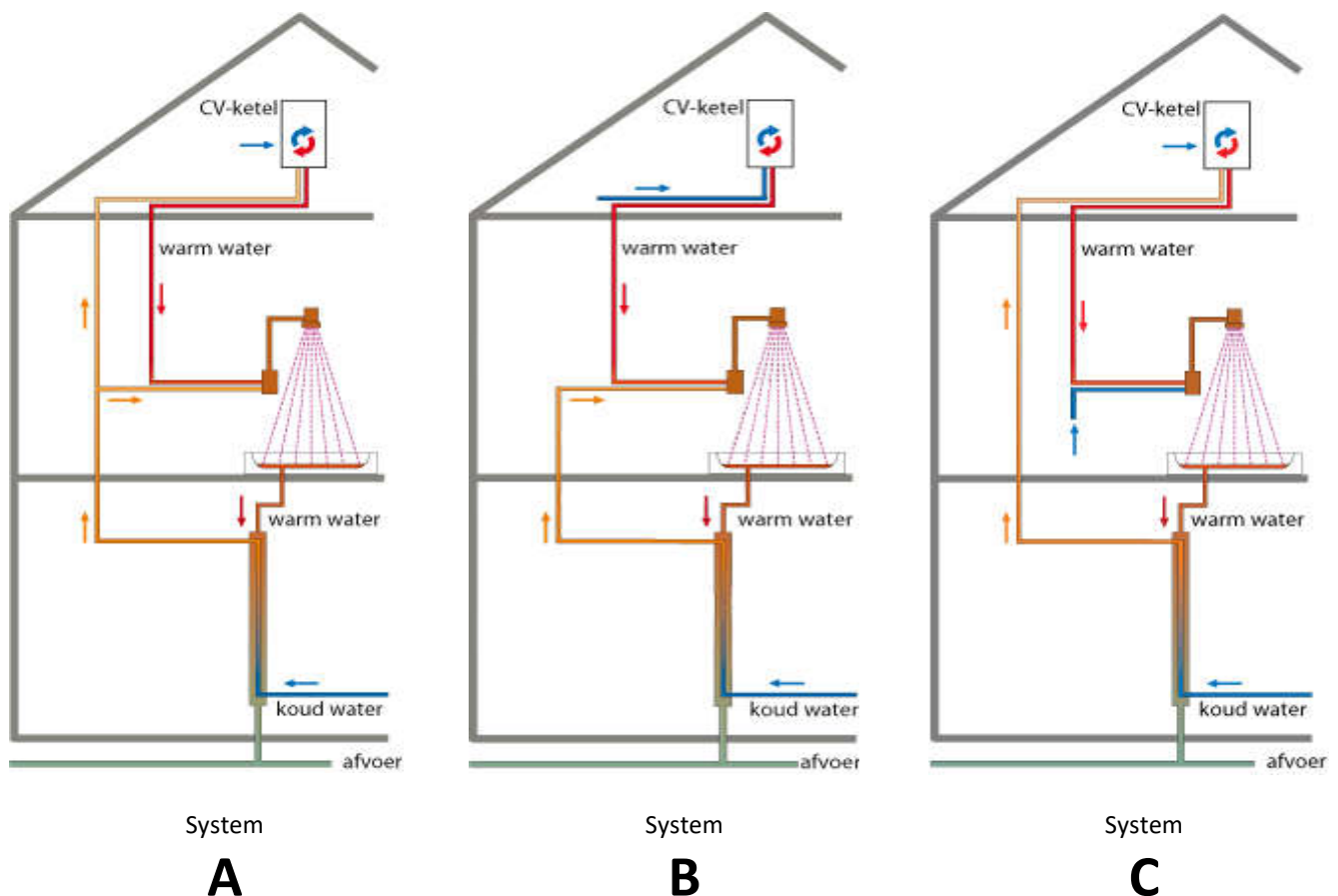

Energy savings:

Connection according to system A gives the maximum efficiency. Connection according to system B or C gives a limited loss of efficiency. It may require additional calculations to determine the exact savings in your home.

Warranty:

Counter Flow provides a **10-year warranty**; improper installation will invalidate the warranty.

Safety:

For application of a shower heat exchanger, a double separation between waste water and potable water must be accomplished in accordance with European regulations (NEN 1717). The Counter Flow Shower Pipe meets this requirement by pinching two copper pipes together. This is a very robust and reliable construction, where the contact between the two pipes is very firm, and independent of the present water pressure. This design meets all safety requirements and you can connect the shower pipe directly to the sewer system, without any atmospheric break.

In most EU countries a non return valve in de cold water supply is mandatory. See “applicable regulations” below on this page.

Comfort:

The use of a thermostatic shower mixer is highly recommended.

Maintenance:

The Counter Flow shower pipe VX is maintenance-free.

Considerations before mounting

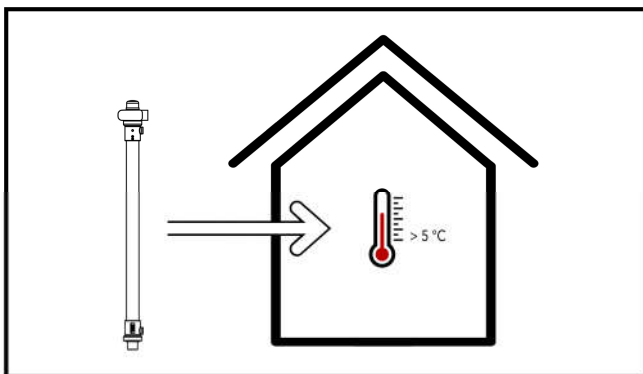

Mount in a frost-free space

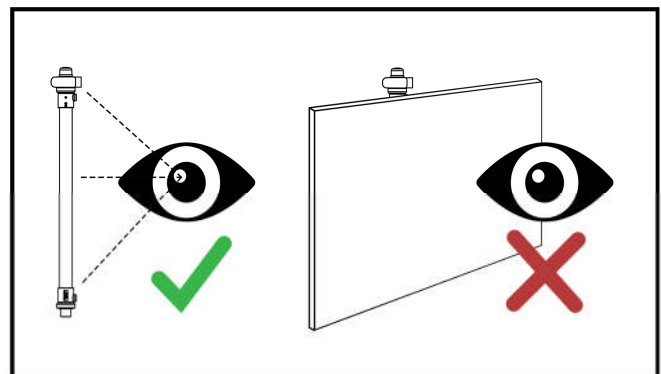

Mount in an accessible space

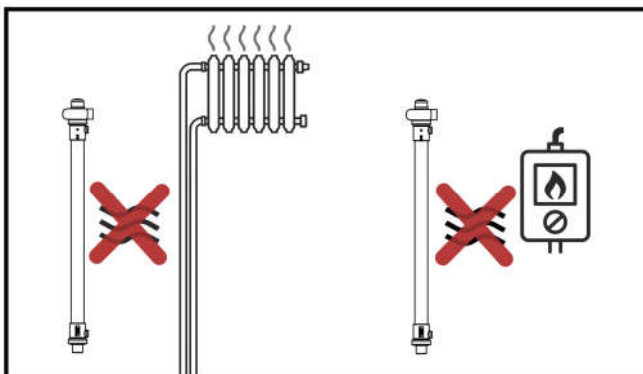

Do NOT mount near other heat sources

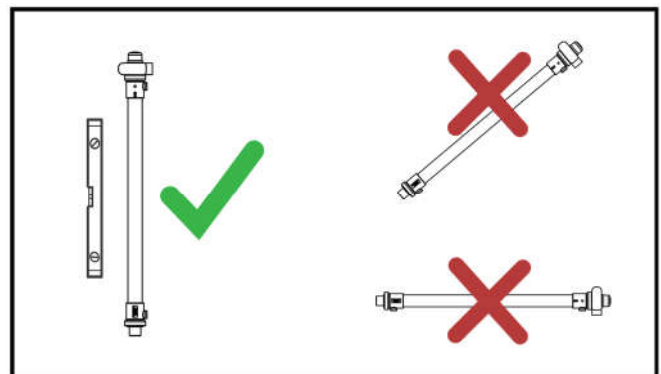

Mount vertically, using a spirit level

APPLICABLE REGULATIONS:

Install this product in accordance with this manual and applicable installation and safety regulations!

Flush the pipes thoroughly with potable water before connecting the product. Only drinking water may be used that meets the requirements of the applicable national and/or local drinking water ordinance.

In most countries, a guideline is available for installing shower heat recovery units. Installation in the meter cupboard is often permitted, provided that the compartment of the WWHRS unit is properly separated from electrical cupboard. Please inform yourself about the exact regulations in your country/region.

Mounting instructions

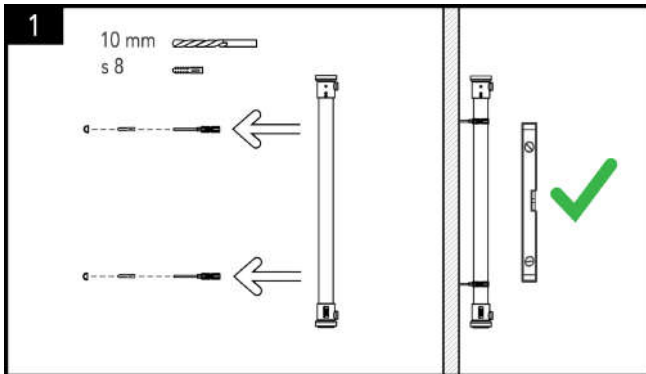

Mount the shower pipe vertically on the wall,

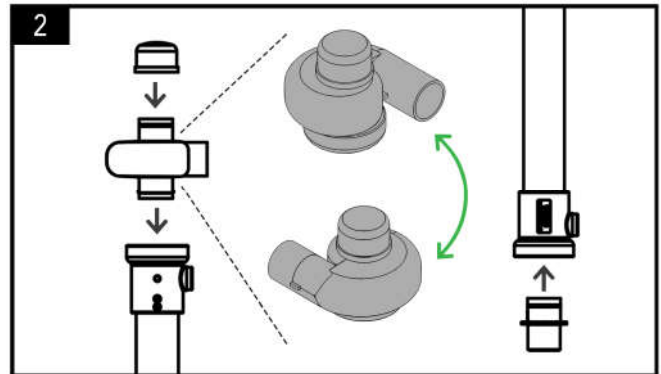

and place the TURBO rotator (top) and connector (bottom).

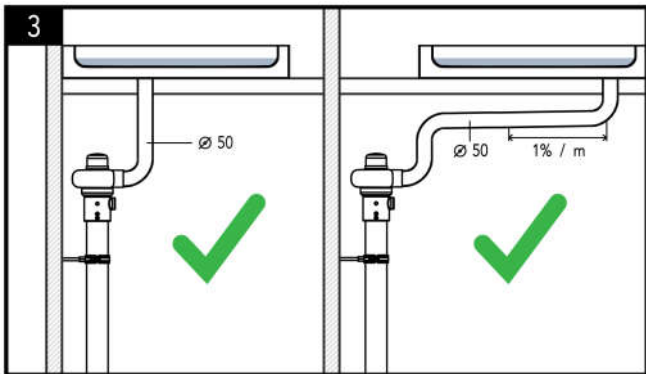

Connect the shower room drain pipe to the rotator,

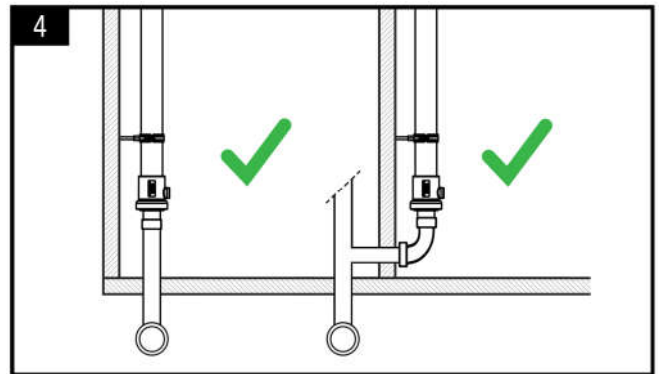

and the bottom of the shower pipe on the sewer.

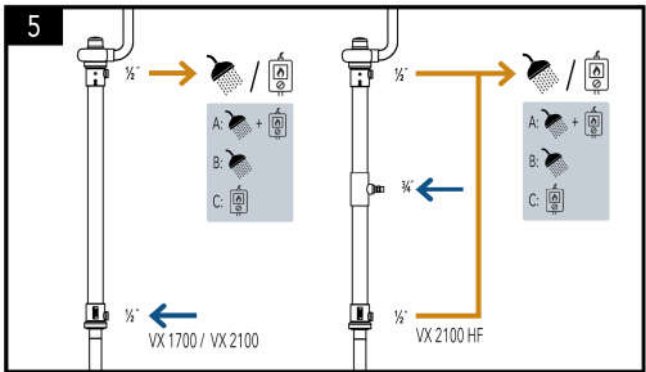

Connect the cold water supply at the bottom (model HF: middle), and lead the preheated water from the outlet (s) to:
 A: the shower tap *and* the water heater, or
 B: the shower tap only, or
 C: the water heater only.

(see schemes on page 3)

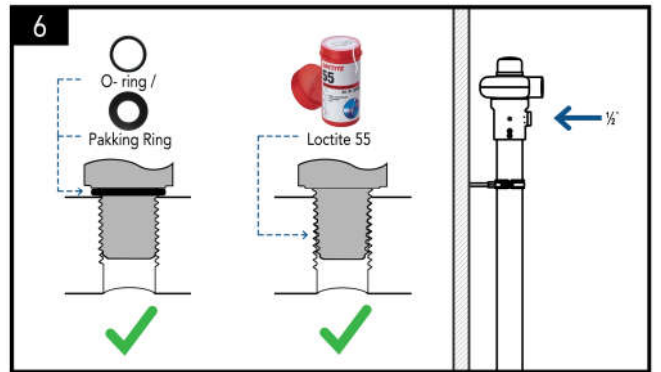

Preferably use sanitary fittings with a ½" BSP conical male thread, and use a little (!) Loctite 55 fiber thread for sealing. **DO NOT OVERTIGHTEN** the fitting; tighten by hand first, and then 1 to 2 extra turns; this should be sufficient! When using straight thread fittings, a gasket or O-ring should be used for sealing.

PS: for model HF, the supplied brass double nipple ¾" must be used in the central connection! A sanitary fitting with ¾" BSP female thread can then be mounted on this nipple.